

# WASHINGTON

HAM RADIO



Owner's manual



PRESIDENT

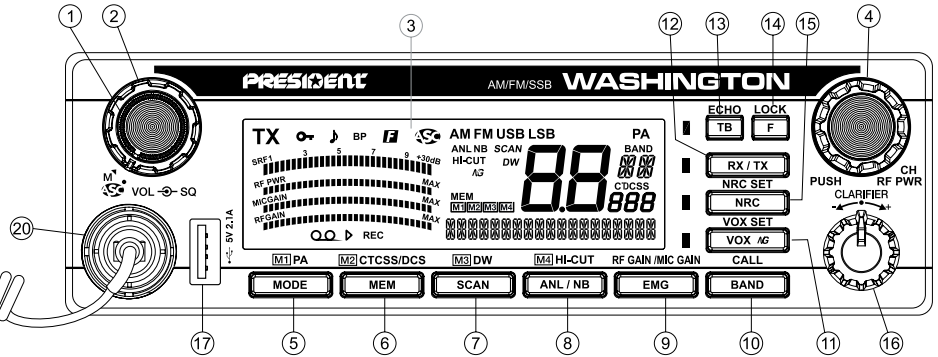
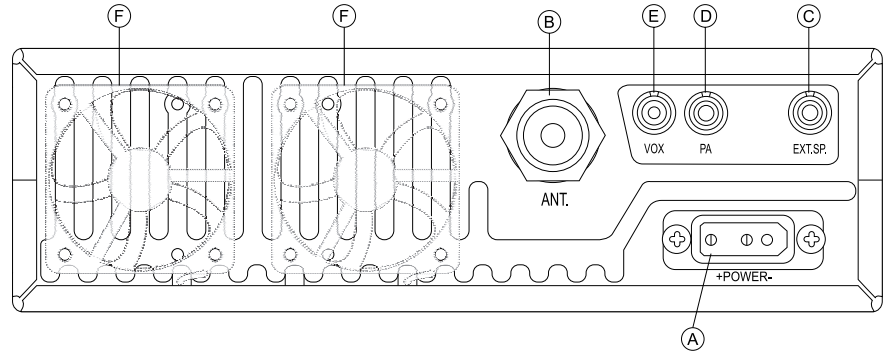
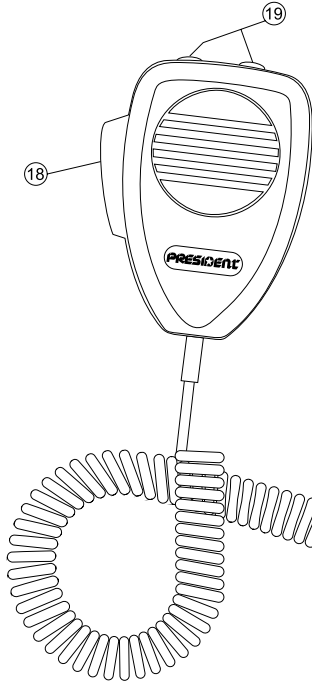

# Your **PRESIDENT WASHINGTON** at a glance

14 + 11	Noise Gate
18 + 4	RF POWER
18 + 9	MIC GAIN
18 + 10	CALL





## SUMMARY

English

INSTALLATION .....	5
HOW TO USE YOUR TRANSCEIVER.....	7
FUNCTIONS WITH THE PTT SWITCH .....	11
MENU .....	12
TECHNICAL CHARACTERISTICS.....	20
TROUBLE SHOOTING .....	21
GLOSSARY .....	21
SIMPLIFIED EU DECLARATION OF CONFORMITY  .....	22
GENERAL WARRANTY CONDITIONS EU  .....	23
GENERAL WARRANTY CONDITIONS USA  .....	24



Your PRESIDENT WASHINGTON is equipped with the **APM** (Automatic Power Management) system, an advanced thermal management system designed to maintain optimal performance even in variable temperature conditions. The system continuously monitors the internal temperature of your radio station. In case of temperature increase, if you have connected fans (optional), they can automatically start to cool the radio station. If necessary, the power of your station is automatically adjusted to reduce generated heat. Additionally, you can customize thermal protection settings by setting your own temperature threshold for fan activation, if desired. This combination of options ensures efficient thermal management, guaranteeing the durability and reliability of your radio station in all usage conditions.

Parts marked with  only concern USA and parts marked with  only concern EU.

 **WARNING:** This product can expose you to chemicals including Lead, which is known to the State of California to cause cancer and birth defects or other reproductive harm. For more information go to [www.P65Warnings.ca.gov](http://www.P65Warnings.ca.gov).

 **AVERTISSEMENT :** Ce produit peut vous exposer à des agents chimiques, y compris le plomb, identifiés par l'État de Californie comme pouvant causer le cancer et des malformations congénitales ou autres effets nocifs sur la reproduction. Pour de plus amples informations, prière de consulter le site [www.P65Warnings.ca.gov](http://www.P65Warnings.ca.gov).

## WARNING !

- *The use of this equipment involves the possession of a Radio Amateur license*
- *Before using, be careful never to transmit without first having connected the antenna (connection "B" situated on the back panel of the equipment) or without having set the SWR (Standing Wave Ratio) ! Failure to do so may result in destruction of the power amplifier, which is not covered by the warranty.*

***The warranty of this transceiver is valid only in the country of purchase.***

Welcome to the world of the new generation of radios. The new **PRESIDENT** range gives you access to top performance transceiver equipment. With the use of up-to-date technology, which guarantees unprecedented quality, your **PRESIDENT WASHINGTON** is a new step in personal communication and is the surest choice for the most demanding of professional radio users. To ensure that you make the most of all its capacities, we advise you to read carefully this manual before installing and using your **PRESIDENT WASHINGTON**.

## A) INSTALLATION

### 1) WHERE AND HOW TO MOUNT YOUR MOBILE RADIO

- a) You should choose a well ventilated place most appropriate setting from a simple and practical point of view.
- b) Your radio should not interfere with the driver or the passengers.
- c) Remember to provide for the passing and protection of different wires (e.g. power, antenna, accessory cabling) so that they do not in any way interfere with the driving of the vehicle.
- d) To install your equipment, use the cradle (1) and the self-tapping screws (2) provided (drilling diameter 3.2 mm). Take care not to damage the vehicle's electrical system while drilling the dash board.
- e) Do not forget to insert the rubber joints (3) between the radio and its support as these have a shock-absorbing effect which permits gentle orientation and tightening of the set.

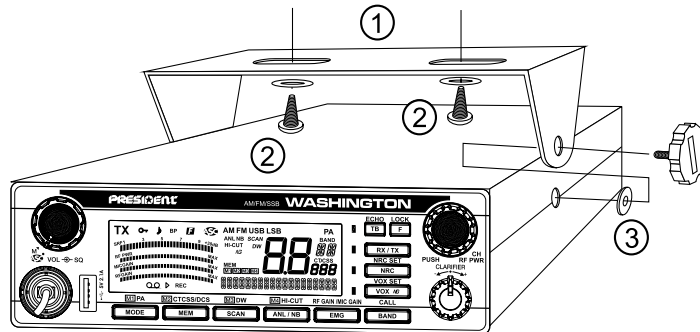

- f) Choose where to place the microphone support and remember that the microphone cord must stretch to the driver without interfering with the controls of the vehicle..

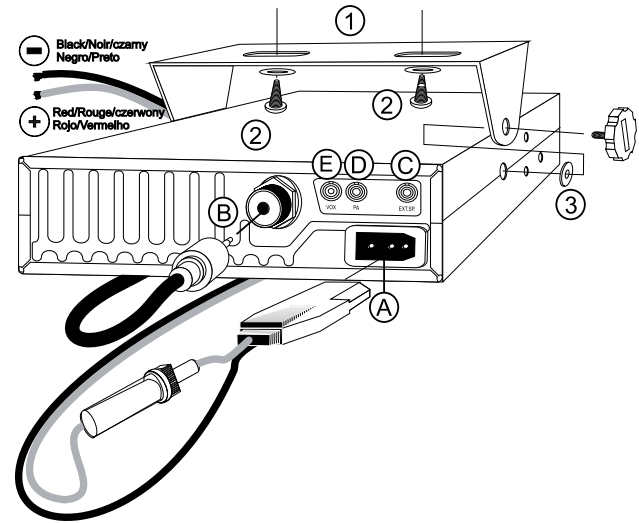

### 2) ANTENNA INSTALLATION

#### a) Choosing your antenna

- For radios, the longer the antenna, the better its results. Your dealer will be able to help you with your choice of antenna.

#### b) Mobile antenna

- Must be fixed to the vehicle where there is a maximum of metallic surface (ground plane), away from windscreen mountings.
- If you already have a radio-telephone antenna installed, the transceiver antenna should be higher than this.
- There are two types of antenna: pre-regulated which should be used on a good ground plane (e.g. car roof or lid of the boot), and adjustable which offer a much larger range and can be used on a smaller ground plane (see § **HOW TO ADJUST SWR**, below).
- For an antenna which must be fixed by drilling, you will need a good contact between the antenna and the ground plane. To obtain this, you should lightly scratch the surface where the screw and tightening star are to be placed.

- Be careful not to pinch or flatten the coaxial cable (as this runs the risk of break down and/or short-circuiting).
- Connect the antenna (B).

### c) Fixed antenna

- A fixed antenna should be installed in as clear space as possible. If it is fixed to a mast, it will perhaps be necessary to stay it, according to the laws in

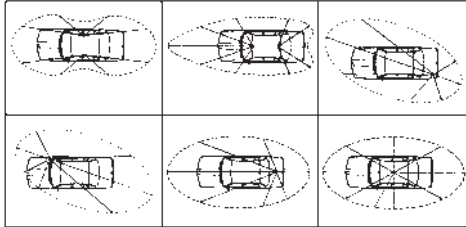

OUTPUT RADIUS PATTERN

force (you should seek professional advice). All PRESIDENT antennas and accessories are designed to give maximum efficiency to each radio within the range.

## 3) POWER CONNECTION

Your PRESIDENT WASHINGTON is protected against an inversion of polarities. However, before switching it on, you are advised to check all the connections. Your equipment must be supplied with a continued current of 12 volts (A). Today, most cars and lorries are negative earth. You can check this by making sure that the negative terminal of the battery is connected either to the engine block or to the chassis. If this is not the case, you should consult your dealer.

**WARNING:** Lorries generally have two batteries and an electrical installation of 24 volts, in which case it will be necessary to insert a 24/12 volt converter (type CV 24/12 PRESIDENT) into the electrical circuit. The following connection steps should be carried out with the power cable disconnected from the set.

- Check that the battery is of 12 volts.
- Locate the positive and negative terminals of the battery (+ is red and - is black). Should it be necessary to lengthen the power cable, you should use the same or a superior type of cable.
- It is necessary to connect your transceiver to a permanent (+) and (-). We advise you to connect the power cable directly to the battery (as the connection of the transceiver cable to the wiring of the car-radio or other

parts of the electrical circuit may, in some cases, increase the likelihood of interference).

- Connect the red wire (+) to the positive terminal of the battery and the black (-) wire to the negative terminal of the battery.
- Connect the power cable to your transceiver radio.

**WARNING:** Never replace the original fuse by one of a different value.

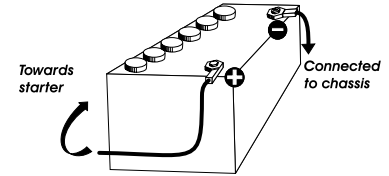

## 4) BASIC OPERATIONS TO BE CARRIED OUT BEFORE USING YOUR SET FOR THE FIRST TIME (without transmitting and without using the "push-to-talk" switch on the microphone)

- Connect the microphone.
- Check the antenna connections.
- Turn the set on by turning the VOL knob (1) clockwise.
- Turn the squelch SQ knob (2) to minimum M.
- Adjust the volume to a comfortable level.
- Go to channel 20 by using the CH rotary knob (4) or UP/DN keys (19) on the microphone.

## 5) HOW TO ADJUST SWR (Standing Wave Ratio)

**Warning:** This must be carried out when you use your radio for the first time and whenever you re-position your antenna. This adjustment must be carried out in an obstacle-free area.

### \* Adjustment with internal SWR-meter

See function SWR CALIBRATION page 15.



### \* Adjustment with external SWR-meter (e.g. TOS-1 PRESIDENT)

#### a) To connect the SWR meter :

- Connect the SWR meter between the transceiver and the antenna as close as possible to the radio (use a maximum of 40 cm cable, type President CA 2C).

#### b) To adjust the SWR meter:

- In AM or FM, using the rotary knob CH (4) or pressing the UP/DN keys (19) on the microphone, position the device in the middle of the band (it is advisable to verify the values obtained on external frequencies).
- Put the switch on the SWR-meter to position FWD (calibration).

- Press the **PTT** "push-to-talk" switch (**18**) on the microphone to transmit.
- Bring the index needle to ▼ by using the calibration key.
- Change the switch to position **REF** (reading of the SWR level). The reading on the Meter should be as near as possible to 1. If this is not the case, readjust your antenna to obtain a reading as close as possible to 1. (A SWR reading between 1 and 1.8 is acceptable).
- It will be necessary to recalibrate the SWR meter after each adjustment of the antenna.

**WARNING:** In order to avoid any losses and attenuations in cables used for connection between the radio and its accessories, PRESIDENT recommends to use a cable with a length inferior to 3 m.

Your transceiver is now ready for use.

## B) HOW TO USE YOUR TRANSCEIVER

### 1) ON/OFF ~ VOLUME

**Turn on :** turn **VOL** knob (1) clockwise. If the function **KEY BEEP** is active (see menu **KEY BEEP** page 12), the radio emits a beep. The radio is "on".

Display briefly shows the microphone type (consult the **MICROPHONE TYPE** menu page 14).

**Turn Off :** turn **VOL** knob (1) counterclockwise until radio emits click sound. Your radio is "off".



Volume Adjustment: rotate **VOL** knob (1) clockwise to *increase* the volume. Turn the same knob counterclockwise to *reduce* the sound level.

### 2) ASC (Automatic Squelch Control) / SQUELCH

**Suppresses** undesirable background noises when there is no communication. Squelch does not affect neither sound or transmission power, but allows a considerable improvement in listening comfort.

#### a) ASC: AUTOMATIC SQUELCH CONTROL

Worldwide patent, a **PRESIDENT** exclusivity.

Turn the **SQ** knob (2) anti-clockwise into **ASC** position.  appears on LCD. No repetitive manual adjustment and a permanent improvement between the sensitivity and the listening comfort when **ASC** is active. This function can be disconnected by turning the switch clockwise. In this case the squelch adjustment becomes manual again.  disappears from LCD.

#### b) MANUAL SQUELCH

Turn the **SQ** knob (2) clockwise to the exact point where all background

noise disappears. This adjustment should be done with precision as, if set to maximum (fully clockwise), only the strongest signals will be received.

### 3) LCD

It shows all functions:

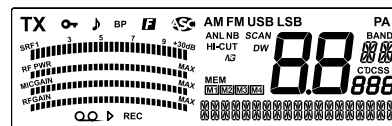

The main bargraph shows the reception level and the output power level. The small bargraphs show Mic Gain, RF Gain and RF Power levels.

### 4) CHANNEL SELECTOR ~ RF POWER CHANNEL SELECTOR

- Turn the rotary **CH** knob (4) to *move* up or down a channel. A beep sound is emitted each time the channel is changed if the **KEY BEEP** function is activated (see **KEY BEEP** function on page 13).

See § **UP/DN BUTTONS ON MICROPHONE** page 11.

The display shows the corresponding frequency.

- A long press (3 seconds) on this button (4) allows entering the **MENU**.
- A short press on this button (4) validates the settings in the **MENU**.

#### RF POWER (combination 18 + 4)

In **TX** mode, *increase/decrease* the output power.

- Press and hold the **PTT** switch (**18**).
- Press **CH** (4) buttons. «RF POWER» is displayed.
- Turn the rotary **CH** knob (4) to *adjust* the level using the bargraph.

### 5) MODE ~ PA ~ M1

#### MODE (short press)

This switch allows **selecting** the modulation mode AM, FM, USB, LSB; Your modulation mode has to correspond to the one of your correspondent.

- **Amplitude Modulation / AM:** communication on a field with relief and obstacles at middle distance (the most used).
- **Frequency Modulation / FM:** for nearby communications on a flat open field.

- **Upper and Lower Side Band/ USB-LSB:** used for long distance communications (according to the propagation conditions)

### **PA (Public Address)** *(long press)*

An external loudspeaker can be connected to the unit by the PA jack plug located on the back panel PA.SP. (D). Turn the **VOL** knob (1) to adjust the **PA** volume.

Long press **MODE** key (5) to *alternate* between **RADIO** and **PA** mode.

For details on operating in **PA** mode, *consult the PA SETTING menu page 14.*

### **M1**

See § **MEMORY** page 8

## **6) MEMORY ~ CTCSS/DCS ~ M2**

### **MEMORY** *(short press)*

This radio allows you to *memorize* 4 channels with the following attributes.

#### **To store into memory:**

- Select the channel and its attributes.
- Press the **MEM** key (6) for one second. If the **KEY BEEP** function is active, a beep sounds. “**MEM**” flashes.
- Press for one second one of the keys **M1** (5), **M2** (6), **M3** (7) or **M4** (8) to memorize. “**MEM**” appears in the display and the number of the selected memory (**M1**, **M2**, **M3** or **M4**) flashes.
- If the **KEY BEEP** function is active, a long beep confirms the success of the operation.

#### **To call a memory:**

- Press the **MEM** key (6) for one second. If the **KEY BEEP** function is active, a beep sounds. “**MEM**” flashes.
- Briefly press one of the **M1** (5), **M2** (6), **M3** (7) or **M4** (8) keys to display the selected memory.
- “**MEM**” is displayed, the number of the selected memory (**M1**, **M2**, **M3** or **M4**) flashes.

### **CTCSS/DCS**

For simplicity, in this manual we will speak of **CTCSS/DCS code** to indicate both a CTCSS tone and a DCS code, of **GENRE** to indicate the kind of code (CTCSS, DCS or OFF = no code). **TYPE** indicates whether this is a TX

transmission or an RX reception and **MODE** specifies the operating mode, identical *id* or different *dF*.

*Consult the **CODE SET** menu page 15.*

*See list of codes on pages 25.*

**Note:** Codes can only be used in **FM**. Each channel can have its own code.

Press for one second one of the **MEM** key (6) to *activate/deactivate* the **CTCSS/DCS** function.

#### **Activation**

If a CTCSS/DCS code has been stored, it becomes active, “**CTCSS**” or “**DCS**” icon is displayed on the screen.

In *MODE id*, if no CTCSS/DCS code has been stored, the device emits an error beep. Go to the **CODE SET** menu to store a CTCSS/DCS code.

In *dF* **MODE**, if no CTCSS/DCS code has been stored in either **TYPE TX** or **TYPE RX**, the device emits an error beep. Go to the **CODE SET** menu to store the CTCSS/DCS codes.

#### **Deactivation**

If a CTCSS/DCS code has been stored and “**CTCSS**” or “**DCS**” is displayed on the screen, a long press on the **MEM** key (6) deactivates the stored code, “**CTCSS**” or “**DCS**” disappears, a deactivation beep sounds. The memorized CTCSS/DCS code is kept in memory but no longer functions.

### **M2**

See § **MEMORY** page 8

## **7) SCAN ~ DW ~ SKIP ~ M3**

### **SCAN** *(short press)*

Press the **SCAN/DW** key (7) to *activate* the **SCAN** function in ascending order. “**SCAN**” is displayed. The scanning stops as a channel is active. The scanning automatically starts 3 seconds after the end of the transmission and no key is activated. In **SCANNING** mode, turn the rotary **CH** knob (4) or use the **UP/DN** buttons (19) on the microphone to change scan direction. *(see § SKIP below)*

Press the **PIT** switch (18) or the **SCAN** key (7) to *exit* the **SCAN** function.

### **DW** *(long press)*

Long press the **SCAN** key (7) *activates* the **DW** (Dual Watch) function. “**DW**” is displayed. This function allows you to watch two channels..



A new short press **SCAN** key (7) *deactivates* the **DW** function. “**DW**” disappears from the display.

**SKIP** (long press only if the **SCAN** function is activated)

This function allows you to *skip* a channel found by the **SCAN** function. When the scan stops on an unwanted channel, press and hold the **SCAN** key (7) for 1 second to *store* this channel in the **SCAN SKIP** memory. A beep sounds. The channel will no longer be scanned. See the § **SCAN** above.

Consult the **SCAN SKIP** menu page 14 and the **RESET** menu page 19.

### M3

See § **MEMORY** page 8

## 8) ANL/NB ~ HI-CUT ~ M4

**ANL/NB** (short press)

Short press the **ANL/NB** key (8) to *activate/deactivate* the filters in this order:

→ ANL → NB → ANL + NB → Off ]

The activated filter is shown on the display.

**ANL - Automatic Noise Limiter:** This filter allows the reduction of background noises and some reception interferences. In **AM** mode only.

**NB - Noise Blanker:** This filter allows the reduction of back ground noise, and some reception interference.

**HI-CUT** (long press)

Long press the **HI-CUT** key (8) to *activate/deactivate* the **HI-CUT** filter. “**HI-CUT**” appears on the display when the filter is active.

**Hi-Cut:** Eliminates high frequency interferences. Has to be used in accordance with the reception conditions.

### M4

See § **MEMORY** page 8

## 9) EMERGENCY CHANNELS ~ RF GAIN ~ MIC GAIN

**EMERGENCY CHANNELS** (short press)

Emergency channels will be automatically *selected* by pressing the **EMG** key (9). First press: emergency channel 1 is activated. Second press: emergency channel 2 is activated. Third press: *return* to the current channel. “**EMG**” appears on the display when an emergency channel is activated.

**RF GAIN** (long press)

Setting the reception sensitivity. Maximum position in the case of long-distance call reception. You can decrease the **RF GAIN**, to avoid distortions, when the interlocutor is near. Reduce the gain on reception in the case of a close communication with a correspondent not equipped with a **RF POWER**.

- Long press the **RF GAIN/MIC GAIN** key (9). “**RF GAIN**” is displayed.
- Turn the rotary **CH** knob (54) to *adjust* the level 01 to 10 or using the bargraph.

The normal position of this function is at maximum level. The bargraph of the **RF GAIN** will always be displayed in reception.

**MIC GAIN** (combination 18 + 9)

Adjust the microphone sensitivity level.

- Press and hold the **PTT** switch (18)
- Press the **RF GAIN/MIC GAIN** key (9). “**MIC GAIN**” is displayed.
- Turn the rotary **CH** knob (4) to *adjust* the level 01 to 10 or using the bargraph.

The normal position of this function is at maximum level. **MIC GAIN** bargraph will be displayed on transmission.

## 10) BAND ~ CALL

**BAND** (short press)

Press the **BAND** key (9) for a fast 200 kHz jump in the segments A / B / C / D / E / F / G / H / I / J

Consult **BAND NAME** menu page 18.

**CALL** (combination 18 + 10)

Press and hold the **PTT** switch (18).

Press the **CALL** key (10) to send a preset call melody. «TX» is displayed.

Consult **CALL SET** menu page 17.

Consult **MESSAGE** menu page 17.

## 11) VOX ~ NOISE GATE ~ VOX SETTING

**VOX** (short press)

The **VOX** function allows *transmitting* by speaking into the original microphone (or in the optional vox microphone) without pressing the **PTT** switch (18). The use of an optional vox microphone connected to the rear panel of the transceiver (E) *disables* the original microphone.

Short press the **VOX** key (11) in order to *activate* the **VOX** function. “**VOX**”

appears on the display. Short press again the **VOX** key (11) to **disable** the function. “**VOX**” disappears.

### **NOISE GATE** (combination 14 + 11)

- Short press the **F** key (14). **NG** appears on the display.
- Short press the **VOX** key (11) to **activate** (⏏) or **deactivate** (⏏) the **NOISE GATE**. “**NG**” is displayed when the function is active.

**Noise Gate:** Prevents amplification of background noise. This results in optimized signal levels.

### **VOX SETTING** (long press)

1. Long press the **VOX** key (11) to **enter** the **VOX SETTING**. “**VOX**” blinks, the current setting and its value appear on the display. Three parameters allow to adjust the **VOX**: Sensitivity **SET**, **L** / Anti-vox level **SET**, **R** / Vox delay time **SET**, **t**.
  - 2a. Turn the **CH** rotary knob (4) or use the **UP/DN** keys (19) on the microphone to **modify** the current parameter then, press the **F** key (14) to **select** next parameter or....
  - 2b. Press first the **F** key (14) to **select** another the parameter and then turn the **CH** rotary knob (4) or use the **UP/DN** keys (19) on the microphone to **modify** the current parameter.
  3. When all adjustments are done, press **PIT** switch (18) to **store** and **exit**. If the **KEY BEEP** function is activated, a long beep sounds to **confirm** the success of the operation (consult the **KEY BEEP** menu page 12).
  4. If no key is pressed for 10 seconds, the unit automatically **exits** the function **VOX SETTING** without **save**.
- **Sensitivity** **SET**, **L**: allows the adjustment of the microphone (original one or optional vox) for an optimum transmission quality. Adjustable level from **1** (high level) to **9** (low level). Default value: **5**.
  - **Anti-Vox** **SET**, **R**: allows disabling the transmission generated by the surrounding noise. The level is adjustable. **⏏** (according the squelch level) and from **1** (without anti-vox) to **9** (low level). Default value: **⏏**.
  - **Delay time** **SET**, **t**: allows avoiding the sudden cut of the transmission by adding a delay at the end of speaking. The level is adjustable from **1** (short delay) to **9** (long delay). Default value: **1**.

**VOX SETTING** doesn't activate the **VOX** function.

### **12) RX/TX** (short press)

This function is only active in USB / LSB mode, and allows you to define how the **CLARIFIER** acts.

- Press the **RX/TX** button (12) to activate/deactivate the **CLARIFIER** in this order :
  - 1- **CLARIFIER** in **RX** LED is green (default)
  - 2- **CLARIFIER** in **TX** LED is red
  - 3- **CLARIFIER** in **RX + TX** LED is orange

### **13) TALKBACK ~ ECHO**

#### **TALKBACK** (short press)

This function allows you to **hear** your own modulation in the internal or external speaker connected to the EXT.SP jack (C). Short press the **TB** key (13) to **activate / deactivate** the **TALKBACK** function. When the function is active, the LED is red.

See § **TALKBACK LEVEL** page 11.

#### **ECHO** (long press)

Long Press **TB** (13) key to **activate/deactivate** the **ECHO** function. The LED is green.

Consult **ECHO LEVEL** and **ECHO DELAY** menu page 16

### **14) F ~ LOCK**

#### **F** (short press)

Allows to **set/validate** functions (see for example § **NOISE GATE** page 9). This key pressed alone don't have any use.

See § **NOISE GATE** page 9.

#### **LOCK** (long press)

Long press **F** (14) keys to **activate/deactivate** the **KEY LOCK** function. When the function is active, “**🔒**” appears on the display.

### **15) NRC ~ SPLIT**

#### **NRC** (short press)

This switchable filter can be used to improve reception and transmission modes..

- Press the **NRC** key (12) to activate/deactivate the **NRC** in this order:
  - 1- **NRC** **RX** LED is green
  - 2- **NRC** **TX** LED is red

3- NRC RX + TX LED is orange

4- NRC Off LED is off.

See **NRC SET** menu page 15.

### **SPLIT** (combination 14 + 15)

The SPLIT function allows you to transmit and receive on separate frequencies.

The radio receives on the current frequency and transmits on the selected frequency.

To activate this function, you must first define a TX frequency offset (see the **SPLIT** menu page 16).

- Press the **F** (14) key once briefly. **F** appears on the display.
- Press the **NRC** (12) key briefly a second time to activate: SPLIT ON or deactivate: SPLIT OFF the function. The selected value or «SPLIT SET», if the transmit frequency offset has not yet been selected, flashes for 3 seconds.

**Note:** When the **SPLIT** function is activated :

- The RX and TX frequency is displayed
- The channel and band flash on the **TX** display.

### **16) CLARIFIER**

The function **CLARIFIER** (16) allows a frequency deviation during LSB/USB reception in order to improve the clearness of your correspondent's voice.

See § **RX/TX** page 10

### **17) USB CHARGING SOCKET**

The **USB** socket (17) can be used to charge smartphones, tablets or other rechargeable devices with 5 V - 2.1 A.

### **18) PTT (Push To Talk)**

Transmission key, press to *transmit* a message, **TX** is displayed and release to *listen* to an incoming communication, **TX** disappears.

### **TOT (Time Out Timer)**

If the transmission using **PTT** switch (18) or **VOX** function is longer than 3 minutes, the display starts blinking and the transmission *ends*. A beep will sound until the **PTT** switch (18) key is released.

### **19) UP/DN KEYS ON MICROPHONE** (short press)

Press **UP/DN** keys (13) on the microphone to *change* the channel. **UP** to *increase* and **DN** to *decrease* the channel.

See **ROTARY KNOB** page 7.

### **20) 6 PIN MICROPHONE PLUG**

The plug is located on the front panel of the transceiver and makes the setting of the equipment into the dashboard easier.

See **Cabling Diagram** page 25.

- A) DC-POWER TERMINAL (13.8 V)**
- B) ANTENNA CONNECTOR (SO-239)**
- C) JACK FOR EXTERNAL OPTIONAL SPEAKER (8 Ω, Ø 3.5 mm)**
- D) PA SPEAKER JACK (8 Ω, Ø 3.5 mm)**
- E) JACK FOR OPTIONAL VOX MICROPHONE (Ø 2.5 mm)**
- F) FANS OPTIONALS (Not supplied with radio)**

### **C) FUNCTIONS WITH THE PTT SWITCH**

#### **1) TALKBACK LEVEL**

This function allows to adjust the volume level of the **TALKBACK**.

1. Activate the **TALKBACK** function.
2. Press and hold the **PTT** switch (18) then turn the **CH** rotary knob (4) to *increase* (clockwise) / *decrease* (counterclockwise) the volume level of the **TALKBACK**.
3. Release the **PTT** switch (18).

#### **2) RF POWER LEVEL**

In **TX** mode, the **RF POWER** can be used to increase/decrease the output power.

- Press and hold the **PTT** transmit switch (18).
- Press the **CH** key (4). «RF POWER» is displayed.
- Use the **CH** rotary selector (4) to adjust the level from 01 to 10 or by using the bar graph.

#### **2) MIC GAIN LEVEL**

Adjusting the microphone sensitivity level.

- Press and hold the **PTT** transmit switch (18)
- Press the **RF GAIN/MIC GAIN** key (9). «MIC GAIN» is displayed.
- Turn the **CH** rotary knob (4) to adjust the level, using steps 01 to 10 or the bar graph.

*The normal position of this function is at maximum. The MIC GAIN bar graph appears on the display.*

## D) MENU

The order of 32 menus is as described in this manual. However, the menu displayed by entering the **MENU** will be the last menu modified by user. The procedure is the same whatever the function is:

Long Press **PUSH** key (4) to **enter** the **MENU**. **F** is displayed.

1. Turn the **CH** rotary knob (4) or use **UP/DN** keys (19) on the microphone to **select** the menu to set.
2. Press **PUSH** key (4) to **validate**. The current color blinks on the display.
3. Turn the **CH** rotary knob (4) or use **UP/DN** keys (19) on the microphone to **modify** the value of the parameter.
4. New press on **PUSH** key (4) to **validate** the chosen value. The parameter stops blinking and if the function has more than one parameter, the next parameter blinks.
5. If no key is pressed, the unit **exits MENU** after 10 seconds. **F** disappears from the display.

**Note:** **UP/DN** keys (19) on the microphone have the same effect as the rotation of the **CH** rotary knob (4). **PTT** switch (18) **validates** the last setting and **exits MENU**. **F** disappears.

### 1) COLOR

Long Press **PUSH** key (4) to **enter** the **MENU**. **F** is displayed.

1. Turn the **CH** rotary knob (4) or use **UP/DN** keys (19) on the microphone to **select** the **COLOR** menu.
2. Press **PUSH** key (4) to **validate**. The current color blinks on the display.
3. Turn the **CH** rotary knob (4) or use **UP/DN** keys (19) on the microphone to **modify** the color of the display.

▶ orange / vert / bleu / cyan / jaune / violet / bleu clair  
 0r / 9r / 6L / 4Y / 4E / PU / 6L

4. Short press **PUSH** key (4) to **validate**. **a)** Return to the point 1 to set another menu or **b)** Short press the **PTT** key (18) to **validate** and **exit** the **MENU**. **F** disappears from the display.
5. If no key is pressed, the unit **exits MENU** after 10 seconds. **F** disappears from the display.

*Default COLOR is: 0r (orange).*

### 2) DIMMER

**DIMMER** function allows **adjusting** the brightness of the lighting. 10 steps from 0 to 9

Long Press **PUSH** key (4) to **enter** the **MENU**. **F** is displayed.

1. Turn the **CH** rotary knob (4) or use **UP/DN** keys (19) on the microphone to **select** the **DIMMER** menu.
2. Press **PUSH** key (4) to **validate**. The current value blinks on the display.
3. Turn the **CH** rotary knob (4) or use the **UP/DN** keys (19) on the microphone to **change** the value of the dimmer.
4. Short press **PUSH** key (4) to **validate**. **a)** Return to the point 1 to set another menu or **b)** Short press the **PTT** key (18) to **validate** and **exit** the **MENU**. **F** disappears from the display.
5. If no key is pressed, the unit **exits MENU** after 10 seconds. **F** disappears from the display.

*Dimmer default value is : 5.*

### 3) TONE

This function allows to **change** the **RX TONE**. 11 steps from -5 to +5

Long Press **PUSH** key (4) to **enter** the **MENU**. **F** is displayed.

1. Turn the **CH** rotary knob (4) or use **UP/DN** keys (19) on the microphone to **select** the **TONE** menu.
2. Press **PUSH** key (4) to **validate**. The current value blinks on the display.
3. Turn the **CH** rotary knob (4) or use the **UP/DN** keys (19) on the microphone to **change** the value of the tone.
4. Short press **PUSH** key (4) to **validate**. **a)** Return to the point 1 to set another menu or **b)** Short press the **PTT** key (18) to **validate** and **exit** the **MENU**. **F** disappears from the display.
5. If no key is pressed, the unit **exits MENU** after 10 seconds. **F** disappears from the display.

*Tone default value is : 0*

### 4) KEY BEEP

When the function is activated, a beep **sounds** when a key is pressed, by changing the channel etc. **"BP"** appears on the display when the function is active.

Long Press **PUSH** key (4) to **enter** the **MENU**. **F** is displayed.

1. Turn the **CH** rotary knob (4) or use **UP/DN** keys (19) on the microphone to **select** the **KEY BEEP** menu.
2. Press **PUSH** key (4) to **validate**. The current value blinks on the display.
3. Turn the **CH** rotary knob (4) or use the **UP/DN** keys (19) on the microphone to **activate (0n)** / **deactivate (0F)** the function.
4. Short press **PUSH** key (4) to **validate**. **a)** Return to the point 1 to set another menu or **b)** Short press the **PTT** key (18) to **validate** and **exit** the **MENU**. **F** disappears from the display.

5. If no key is pressed, the unit **exits MENU** after 10 seconds. **F** disappears from the display.

Default **KEY BEEP** is **On**.

## 5) ROGER BEEP

When the function is active, the icon  appears on the display.

The Roger Beep **sounds** when the **PTT** switch (12) on the microphone is released in order to let your correspondent speak. Historically as transceiver is a "simplex" communication mode, it is not possible to speak and to listen at the same time (as it is the case with a telephone). Once someone had finished talking, he said "Roger" in order to prevent his correspondent that it was his turn to talk. The word "Roger" has been replaced by a significant beep. There comes "Roger beep" from.

Long Press **PUSH** key (4) to **enter** the **MENU**. **F** is displayed.

1. Turn the **CH** rotary knob (4) or use **UP/DN** keys (19) on the microphone to **select** the **ROGER BEEP** menu.
2. Press **PUSH** key (4) to **validate**. The current value blinks on the display.
3. Turn the **CH** rotary knob (4) or use the **UP/DN** keys (19) on the microphone to **activate** (  $\uparrow$  to  $\downarrow$  ) / **deactivate** (**OFF**) the function.
4. Short press **PUSH** key (4) to **validate**. **a)** Return to the point 1 to set another menu or **b)** Short press the **PTT** key (18) to **validate** and **exit** the **MENU**. **F** disappears from the display.
5. If no key is pressed, the unit **exits MENU** after 10 seconds. **F** disappears from the display.

\*6 roger tones for **ROGER BEEP**.

Default **ROGER BEEP** is **OFF**.

## 6) INDIC

Use this function to select the information to be displayed.

In RX mode:

Frequency is displayed continuously.

In TX mode:

Long Press **PUSH** key (4) to **enter** the **MENU**. **F** is displayed.

1. Turn the **CH** rotary knob (4) or use **UP/DN** keys (19) on the microphone to **select** the **INDIC** menu.
2. Press **PUSH** key (4) to **validate**. The current value blinks on the display.
3. Turn the **CH** rotary knob (4) or use the **UP/DN** keys (19) on the microphone to **select** the function to be displayed. **FREQUENCY ~ SWR ~ TOT** is displayed alternately. Each time the **PTT** is pressed, the display indicates the voltage and function selected.

4. Short press **PUSH** key (4) to **validate**. **a)** Return to the point 1 to set another menu or **b)** Short press the **PTT** key (18) to **validate** and **exit** the **MENU**. **F** disappears from the display.
5. If no key is pressed, the unit **exits MENU** after 10 seconds. **F** disappears from the display.

## 7) DC \ TEMP

This function is used to select the information to be displayed to the right of the frequency in RX and TX mode.

Long Press **PUSH** key (4) to **enter** the **MENU**. **F** is displayed.

1. Turn the **CH** rotary knob (4) or use **UP/DN** keys (19) on the microphone to **select** the **DC \ TEMP** menu.
2. Press **PUSH** key (4) to **validate**. The current value blinks on the display.
3. Turn the **CH** rotary knob (4) or use the **UP/DN** keys (19) on the microphone to **select** the function to be displayed. **POWERSUPPLY ~ TEMPERATURE** will appear to the right of the parameter selected in **INDIC**.
4. Short press **PUSH** key (4) to **validate**. **a)** Return to the point 1 to set another menu or **b)** Short press the **PTT** key (18) to **validate** and **exit** the **MENU**. **F** disappears from the display.
5. If no key is pressed, the unit **exits MENU** after 10 seconds. **F** disappears from the display.

## 8) SCAN MODE

Allows to **select** the **MODE** of **SCAN**.

Long Press **PUSH** key (4) to **enter** the **MENU**. **F** is displayed.

1. Turn the **CH** rotary knob (4) or use **UP/DN** keys (19) on the microphone to **select** the **SCAN MODE** menu.
2. Press **PUSH** key (4) to **validate**. The current value blinks on the display.
3. Turn the **CH** rotary knob (4) or use the **UP/DN** keys (19) on the microphone to **select** the mode **EH** or **RE**.
4. Short press **PUSH** key (4) to **validate**. **a)** Return to the point 1 to set another menu or **b)** Short press **PTT** key (18) to **validate** and **exit** the **MENU**. **F** disappears from the display.
5. If no key is pressed, the unit **exits MENU** after 10 seconds. **F** disappears from the display.

"EH" means that the station scans all 40 channels of the active frequency band.

"RE" means that the station scans memorized and priority channels only.

Default mode is: **EH**.

## 9) SCAN TYPE

Allows to *select* the **TYPE** of **SCAN**.

Long Press **PUSH** key (4) to *enter* the **MENU**. **F** is displayed.

1. Turn the **CH** rotary knob (4) or use **UP/DN** keys (19) on the microphone to *select* the **SCAN TYPE** menu.
2. Press **PUSH** key (4) to *validate*. The current value blinks on the display.
3. Turn the **CH** rotary knob (4) or use the **UP/DN** keys (19) on the microphone to *select* the scan type **59** or **L**.
4. Short press the **PUSH** key (4) to *validate*. **a**) Return to the point **1** to set another menu or **b**) Short press the **PTT** key (18) to *validate* and *exit* the **MENU**. **F** disappears from the display.
5. If no key is pressed, the unit *exits MENU* after 10 seconds. **F** disappears from the display.

“59” means scanning stops when busy channel is found.

“L” means scanning stops when busy channel is found and return to scan after 5 seconds.

Type default value is : 59.

## 10) SCAN SKIP

This function allows to *memorize/erase* a channel from the **SCAN SKIP memory**.

1. Select a channel
2. Long Press **PUSH** key (4) to *enter* the **MENU**. **F** is displayed.
3. Turn the **CH** rotary knob (6) or use **UP/DN** keys (13) on the microphone to *select* the **SCAN SKIP** menu.
4. Press **PUSH** key (4) to *validate*. The current value blinks on the display.
5. Turn the **CH** rotary knob (4) or use the **UP/DN** keys (19) on the microphone to *alternate* between **On** and **Off**.
6. Short press **PUSH** key (4) to *validate*. **a**) Return to the point **1** to set another menu or **b**) Short press **PTT** key (18) to *validate* and *exit* the **MENU**. **F** disappears from the display.
7. If no key is pressed, the unit *exits MENU* after 10 seconds. **F** disappears from the display.

**On** memorizes the current channel into the **SCAN SKIP memory**. When a channel is stored in the memory, **Sk** appears on the display close to the channel number.

**Off** erases the current channel from the **SCAN SKIP memory**, **Sk** disappears from the display.

See § **SKIP** on page 8.

## 11) PA SETTING

This function allows to *select* the operating mode of Public Address.

Long Press **PUSH** key (4) to *enter* the **MENU**. **F** is displayed.

1. Turn the **CH** rotary knob (4) or use **UP/DN** keys (19) on the microphone to *select* the **PA SETTING** menu.
2. Press **PUSH** key (4) to *validate*. The current value blinks on the display.
3. Turn the **CH** rotary knob (4) or use the **UP/DN** keys (19) on the microphone to *select* the operating mode of the PA : **In**, **Off** or **PR**.
4. Short press **PUSH** key (4) to *validate*. **a**) Return to the point **1** to set another menu or **b**) Short press **PTT** key (18) to *validate* and *exit* the **MENU**. **F** disappears from the display.
5. If no key is pressed, the unit *exits MENU* after 10 seconds. **F** disappears from the display.

**In**: the modulation of the microphone is transmitted to the external loudspeaker connected to jack PA.SP. (D). The received signal is transmitted to the internal loudspeaker (or external optional loudspeaker connected to jack EXT.SP (E). “PA” blinks alternately with the modulation mode (AM or FM).

**Off**: The reception is no more functional. Only the modulation of the microphone is transmitted to the Public Address loudspeaker connected to jack PA.SP. (D). **PR** is displayed.

**PR**: the modulation of the microphone and the received signal are transmitted to the Public Address loudspeaker connected to jack PA.SP. (D). “PA” blinks alternately with the modulation mode (AM or FM).

Turn the **VOL** knob (1) to *adjust* the audio level of the mode **PA**.

See § **PA (Public Address)** page 8.

## 12) MICROPHONE TYPE

PRESIDENT WASHINGTON can be used with both a PRESIDENT electret and dynamic 6-pin microphone (see *microphone wiring* on page 25). When the unit is turned on, the microphone type is displayed briefly.

Long Press **PUSH** key (4) to *enter* the **MENU**. **F** is displayed.

1. Turn the **CH** rotary knob (4) or use **UP/DN** keys (19) on the microphone to *select* the **MIC TYPE** menu.
2. Press **PUSH** key (4) to *validate*. The current value blinks on the display.
3. Turn the **CH** rotary knob (4) or use the **UP/DN** keys (19) on the microphone to *select* the microphone type **EL** (electret) or **dH** (dynamic).
4. Short press the **PUSH** key (4) to *validate*. **a**) Return to the point **1** to set another menu or **b**) Short press the **PTT** key (18) to *validate* and *exit* the **MENU**. **F** disappears from the display.

5. If no key is pressed, the unit **exits MENU** after 10 seconds. **F** disappears from the display.

Microphone type default is **EL** (electret).

### 13) SWR CALIBRATION

This function allows you to monitor the swr digitally and audibly (via beep) while making adjustments.

Long Press **PUSH** key (4) to **enter** the **MENU**. **F** is displayed.

1. Turn the **CH** rotary knob (4) or use **UP/DN** keys (19) on the microphone to **select** the **SWR** menu.
2. Press **PUSH** key (4) to **confirm**. The radio automatically switches to **TX** mode without pressing the **PTT** switch (18) and calibration begins. Calibration time is 5 minutes maximum. A countdown is done in the display.
3. Adjust the antenna.
  - The beep\* is continuous when the SWR value is **1.0**. The space between the beeps becomes larger and larger as the SWR value moves away from **1.0**.
  - The volume of the beep is adjustable with **VOL** knob (1).
  - The display shows the SWR value, for example **2.5**.
4. Press the **PTT** switch (18) to **exit SWR CALIBRATION**.

\*Check that the beep volume is set to a suitable level.

See **ADJUSTMENT OF SWR** page 6.

### 14) NRC SET

The **NRC** filter can be set independently in transmission (T) as in reception (R).

Long Press **PUSH** key (4) to **enter** the **MENU**. **F** is displayed.

1. Turn the **CH** rotary knob (4) or use **UP/DN** keys (19) on the microphone to **select** the **NRC SET** menu. The last parameter used and its value appears on the display.
2. Press the **PUSH** key (4) to **confirm**. The parameter blinks, RX or TX.
3. Turn the **CH** rotary knob (4) or use the **UP/DN** keys (19) on the microphone to **select** RX (reception) or TX (transmission).
4. Press **PUSH** key (4) to **confirm**. The value of the filter blinks.
5. Turn the **CH** rotary knob (4) or use the **UP/DN** keys (19) on the microphone to **change** the value from **0.1** to **0.5**.
6. Short press **PUSH** key (4) to **validate**. a) Return to the point 1 to set another menu or b) Short press **PTT** key (18) to **validate** and **exit** the **MENU**. **F** disappears from the display.

The default value are **0.1** (transmission) and **0.1** (reception)

See the § **NRC** page 10 to **activate/deactivate** the function.

### 15) CODE SET

For simplicity, in this manual we will speak of **CTCSS/DCS code** to indicate both a CTCSS tone and a DCS code, of **GENRE** to indicate the kind of code (CTCSS, DCS or OFF = no code). **TYPE** indicates whether this is a TX transmission or an RX reception and **MODE** specifies the operating mode, Identical Id or different DF. See § **CTCSS/DCS** page 8.

This menu allows you to configure the operating mode of the **CTCSS/DCS** function and to store the CTCSS/DCS codes.

2 operating modes:

- **Id** means that the code used will be identical for transmission (**TX**) and for reception (**RX**).
- **DF** means that the user can use one code (or OFF = no code) for transmission (**TX**) and another (or OFF = no code) for reception (**RX**).

Long Press **PUSH** key (4) to **enter** the **MENU**. **F** is displayed.

#### OPERATING MODE

1. Turn the **CH** rotary knob (4) or use the **UP/DN** keys (19) on the microphone to **select** the **CODE** menu.
2. Briefly press the **PUSH** key (4) to **confirm**. The operating mode flashes (**Id** or **DF**).
3. Turn the **CH** rotary knob (4) or use the **UP/DN** keys (19) on the microphone to **select** the desired operating mode.

#### STORING A CTCSS/DCS CODE

Depending on the operating mode used, the procedure differs:

##### Identical mode Id

4. Short press on the **PUSH** key (4) makes the genre blink (“CTCSS”, “DCS” or “OFF” no genre).
5. Turn the **CH** rotary knob (4) or use the **UP/DN** keys (19) on the microphone to **select** the genre or...
6. Press the **PUSH** key (4) to **confirm** the genre. The code value flashes (unless **OFF** selected).
7. Turn the **CH** rotary knob (4) or use the **UP/DN** keys (19) on the microphone to **select** the code (from 01 to 38 for CTCSS and 001 to 104 for DCS).

##### Different Mode DF

4. Short press on the **PUSH** key (4) makes the type **RX** blink.
5. Turn the **CH** rotary knob (4) or use the **UP/DN** keys (19) on the microphone to **select** the **RX** or **TX** type.

- A short press on the **PUSH** key (4) *validates* the choice of type. The genre value flashes ("CTCSS", "DCS" or "OFF" no genre).
- Turn the **CH** rotary knob (4) or use the **UP/DN** keys (19) on the microphone to *select* the genre or...
- Press the **PUSH** key (4) to *confirm* the genre. The code value flashes (unless OFF has been selected).
- Turn the **CH** rotary knob (4) or use the **UP/DN** keys (19) on the microphone to *select* the code (01 to 38 for CTCSS 001 to 104 for DCS).
- Press **PUSH** key (4) to *confirm* the selected code. The unit returns to point 5, to set the second type.
- If you don't need to set the second type, long press the **PUSH** key (4) to *validate* and exit the **MENU**.
- If no key is pressed, the device *exits* the **MENU** after 10 seconds without *saving* the changes.

The default mode is **1d** (Identical). The default genre is OFF.

See the **RESET** menu.

## 16) EMERGENCY CHANNEL

Long Press **PUSH** key (4) to *enter* the **MENU**. **F** is displayed.

- Turn the **CH** rotary knob (4) or use the **UP/DN** keys (19) on the microphone to *select* the **EMG SETTING EMG 1** menu.
- Press **PUSH** key (4), turn the **CH** knob (4) or use the **UP/DN** keys (19) on the microphone to *select* the priority channel to set **EMG 1** or **EMG 2**.
- Press **PUSH** key (4). The channel flashes in the display.
- Turn **CH** knob (4) or use the **UP/DN** keys (19) on the microphone to select the channel.
- Press **MODE** (5) to *select* AM, FM, USB and LSB mode.
- Press **PUSH** key (4) again to *confirm*. The channel stops flashing. **a**) Start again at point 1 to *set* another function or **b**) Press the **PIT** switch (18) to *exit MENU*.
- If no key is pressed, the unit *exits* the **MENU** after 10 seconds. **F** disappears from the display.

Default Emergency channel 1 is **9** in AM.

Default Emergency channel 2 is **19** in AM.

See § **EMERGENCY CHANNELS** page 9.

## 17) DW (DUAL WATCH)

This function allows you to customize the second channel scanned by the DUAL WATCH function.

Long Press **PUSH** key (4) to *enter* the **MENU**. **F** is displayed.

- Turn the **CH** rotary knob (4) or use the **UP/DN** keys (19) on the microphone to *select* the **SET** menu.
- Press the **PUSH** key (4). The **channel** flashes in the display.
- Turn **CH** knob (4) or use the **UP/DN** keys (19) on the microphone to select the channel.
- Press **MODE** (5) to *select* AM, FM, USB and LSB mode.
- Press **PUSH** key (4) again to *confirm*. The channel stops flashing. **a**) Start again at point 1 to *set* another function or **b**) Press the **PIT** switch (18) to *exit MENU*
- If no key is pressed, the unit *exits* the **MENU** after 10 seconds. **F** disappears from the display.

## 18) SPLIT (REPEATER)

This function allows you to customise the TX frequency offset.

Long Press **PUSH** key (4) to *enter* the **MENU**. **F** is displayed.

- Turn the **CH** rotary knob (4) or use the **UP/DN** keys (19) on the microphone to *select* the **SPLIT** menu.
- Press the **PUSH** key (4) to set the repeater function to OFFSET and DIRECTION.
- Turn the **CH** rotary knob (4) or use the **UP/DN** keys (19) on the microphone to select the DIRECTION. When «**+**» is displayed, the offset is positive in the current channel. When «**-**» is displayed, the offset is negative in the current channel. «**0F**» means no offset.
- Press the **PUSH** key (4) to confirm. The OFFSET value flashes.
- Turn the **CH** rotary knob (4) or use the **UP/DN** keys (19) on the microphone to set the desired offset.
- a**) Press the **PUSH** key (4) again briefly to confirm and move on to the next digit.
- b**) Press and hold the button for 1 second to confirm and exit the **MENU**. **F** disappears from the display.
- If no key is pressed, the device exits the **MENU**s after 10 seconds. **F** disappears from the display.

## 19) SPAN SETTING

When the function is active, the frequency can be adjusted continuously. Pressing the **PUSH** knob (4) displays a bar under the first or second decimal of the frequency. The **CH** rotary knob (4) no longer acts on the channel but executes a jump frequency.

Long Press **PUSH** key (4) to *enter* the **MENU**. **F** is displayed.

- Turn the **CH** rotary knob (4) or use **UP/DN** keys (19) on the microphone to



select the **SPAN** SETTING menu.

2. Press **PUSH** key (4) to **validate**. The current value blinks on the display.
3. Turn the **CH** rotary knob (4) or use the **UP/DN** keys (19) on the microphone to **activate** (a) / **deactivate** (aF) the function.
4. Short press the **PUSH** key (4) to **validate**. a) Return to the point 1 to set another menu or b) Short press the **PTT** key (18) to **validate** and **exit** the **MENU**. **F** disappears from the display.
5. If no key is pressed, the unit **exits MENU** after 10 seconds. **F** disappears from the display.

Default **SPAN** is aF.

## 20) CALL SET

Set the **FREQUENCY** of the **CALL** tone.

Setting the **CALL TONE FREQUENCY**.

Long Press **PUSH** key (4) to **enter** the **MENU**. **F** is displayed.

1. Turn the **CH** rotary knob (4) or use **UP/DN** keys (19) on the microphone to **select** the **CALL SET** menu.
2. Press **PUSH** key (4) to **validate**. The current value blinks on the display.
3. Turn the **CH** rotary knob (4) or use the **UP/DN** keys (19) on the microphone to **set** the type of tone «Fr» frequency or «fTE» message.
4. Short press the **PUSH** key (4) to **validate**.
- 5a. If you have selected «Fr» frequency, you will be asked to set the frequency. Turn the **CH** rotary knob (4) or use the **UP/DN** keys (19) on the microphone to **set** the frequency.  
Frequency range: 300 Hz ~ 3000 Hz. Step size: 10 Hz. Default value: 1050 Hz. Press the **PUSH** key (4) to modify the step.
- 5b. If you have selected «fTE» message, instead of the tone, the **CALL** function will play the message recorded in the **MESSAGE** menu (see next §).
- 6a. Press the **PUSH** key (4) again briefly to confirm and remain in the **MENUS**.
- 6b. Press and hold for 1 second to confirm and exit the **MENUS**. **F** disappears from the display.
7. If no key is pressed, the unit **exits MENU** after 10 seconds. **F** disappears from the display.

## 21) MESSAGE

This function can be used to record a message of up to 30 seconds, which can then be transmitted using the **CALL** function.

Long Press **PUSH** key (4) to **enter** the **MENU**. **F** is displayed.

1. Turn the **CH** rotary knob (4) or use **UP/DN** keys (19) on the microphone to

select the **MESSAGE** menu.

2. Press the **PUSH** key (4) to **validate**. «QD» flashes on the display. You can choose between «PLAT» or «RECORD»  
«PLAT» to listen to the previously recorded message.
- 3a. Press the **SCAN** key (7) to listen to the message.  
«QD» flashes on the display.  
«RECORD» allows you to record a message up to 30s long. The previously recorded message will be erased.
- 3b. Take the microphone in your hand. You don't need to press PTT. Press the **ANL/NB** key (8) to start recording the message. «QD REC» flashes on the display, the remaining time is shown. Press the **ANL/NB** key (8) again to stop recording.
4. Press the **PUSH** key (4) again to confirm the selected value. «QD» stops flashing. a) Start again at point 1 to **set** another function or b) Press the **PTT** switch (18) to **exit MENU**
5. If no key is pressed, the unit **exits** the **MENU** after 10 seconds. **F** disappears from the display.

## 22) AUTOMATIC RELAY

This function turns your **PRESIDENT WASHINGTON** into an automatic relay point.

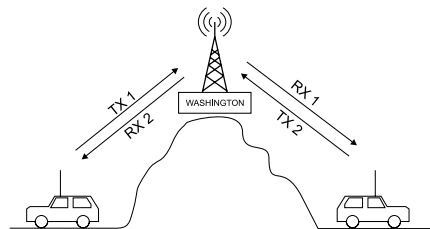

Once set up, your radio will automatically transmit the message received on the RX reception channel to the TX transmission channel. The duration of the message is limited to 5 minutes.

When the function is active, your radio is locked.

To unlock it, see the **LOCK** function on page 10.

If there is a power cut, your radio will resume its configuration and the **AUTOMATIC RELAY** function will remain active.

To activate the **AUTOMATIC RELAY** function, you must first :

- be in FM mode (see § *MODE* page 7)
- select the **RX** channel. (see § *CHANNEL SELECTOR* page 7)
- have set a **CTCSS/DCS** code - in **RX** mandatory. (see § *CODE SET* page 15)
- have activated the **CTCSS/DCS** function (see § *CTCSS/DCS* page 8)
- if necessary, have configured a frequency offset using the **SPLIT** function (REPEATER). (see § *SPLIT* page 16)

Long Press **PUSH** key (4) to enter the **MENU**. **F** is displayed.

1. Turn the **CH** rotary knob (4) or use **UP/DN** keys (19) on the microphone to select the **AUTOMATIC RELAY** menu.
2. Press **PUSH** key (4) to *validate*. The current value blinks on the display.
3. Turn the **CH** rotary knob (4) or use the **UP/DN** keys (19) on the microphone to *activate* (a $\bar{n}$ ) / *deactivate* (a $\bar{F}$ ) the function.
4. Press the **PUSH** key (4) again to *confirm* your choice.

- Choice *activate* **a $\bar{n}$**  :

If all the required parameters are activated, the terminal locks and displays «AUTOMATIC RELAY»; if not, an error message is displayed. To unlock the unit, refer to § **LOCK** page 10.

- Choice to *disable* **a $\bar{F}$**  :

The value stops flashing. **a**) Return to the point 1 to set another menu or **b**) Short press the **PTT** key (18) to *validate* and *exit* the **MENU**. **F** disappears from the display.

5. If no key is pressed, the unit *exits MENU* after 10 seconds. **F** disappears from the display.

*The default value for the function is a $\bar{F}$  (disable).*

## 23) BAND NAME

This function allows bands to be renamed with two digits.

1. Press the **BAND** key (10) to select the band to be *modified*.
2. Long Press **PUSH** key (4) to enter the **MENU**. **F** is displayed.
1. Turn the **CH** rotary knob (4) or use **UP/DN** keys (19) on the microphone to *select* the **BAND NAME** menu.
4. Push **PUSH** key (4). The first digit flashes in the display.
5. Turn the rotary knob **PUSH** (6) or use **UP/DN** key (19) on the microphone to select the character for the first digit.
6. Push **PUSH** key (6) to *validate* the first digit. the second digit flashes on the display.
7. Turn the rotary knob **PUSH** (6) or use **UP/DN** key (19) on the microphone to select the character for the second digit.

8. Press the **PUSH PUSH** key (6) again to confirm the new name assigned to the tape selected in step 1. The second digit stops flashing. **a**) Return to the point 1 to set another menu or **b**) Short press the **PTT** key (18) to *validate* and *exit* the **MENU**. **F** disappears from the display.

9. If no key is pressed, the unit *exits MENU* after 10 seconds. **F** disappears from the display.

*The default band name is : A / B / C / D / E / F / G / H / I / J. See **RESET** menu-page 20.*

*See § **BANDE** page 9.*

## 24) VOLUME ACCESSORY

This function allows you to control the volume of the unit and an accessory plugged on the 6-pin plug (accessory available soon).

Long Press **PUSH** key (4) to enter the **MENU**. **F** is displayed.

1. Turn the **CH** rotary knob (4) or use **UP/DN** keys (19) on the microphone to *select* the **VOL ACC** menu.
2. Press **PUSH** key (4) to *validate*. The current value blinks on the display.
3. Turn the **CH** rotary knob (4) or use the **UP/DN** keys (19) on the microphone to *select* **00**, **01** or **02**.
4. Short press the **PUSH** key (4) to *validate*. **a**) Return to the point 1 to set another menu or **b**) Short press the **PTT** key (19) to *validate* and *exit* the **MENU**. **F** disappears from the display.
5. If no key is pressed, the unit *exits MENU* after 10 seconds. **F** disappears from the display.

**00** - the **vol** knob (1) affects the internal speaker volume.

**01** - the **vol** knob (1) affects the accessory volume

**02** - the **vol** knob (1) affects both the internal speaker and accessory volume.

*Default accessory volume is 00.*

## 25) SWR PROTECTION SETTING

*Set the **SWR LEVEL PROTECTION**.*

Long Press **PUSH** key (4) to enter the **MENU**. **F** is displayed.

1. Turn the **CH** rotary knob (4) or use **UP/DN** keys (19) on the microphone to *select* the **SWR PROTECTION** menu.
2. Press **PUSH** key (4) to *validate*. The current value blinks on the display.
3. Turn the **CH** rotary knob (4) or use the **UP/DN** keys (19) on the microphone. We recommend a setting of 3.0 for the SWR protection.
4. Short press the **PUSH** key (4) to *validate*. **a**) Return to the point 1 to set another menu or **b**) Short press the **PTT** key (18) to *validate* and *exit* the **MENU**. **F** disappears from the display.

5. If no key is pressed, the unit **exits MENU** after 10 seconds. **F** disappears from the display.

Default value is **30**

## 26) MAXI. VOLTAGE PROTECTION LIMIT

Set the **MAXIMUM LIMIT** of **VOLTAGE PROTECTION**.

Long Press **PUSH** key (4) to **enter** the **MENU**. **F** is displayed.

- Turn the **CH** rotary knob (4) or use the **UP/DN** keys (19) on the microphone to **select** the **VOLTY PROTECTION** menu.
- Press **PUSH** key (4) to **validate**. The current value blinks on the display.
- Turn the **CH** rotary knob (4) or use the **UP/DN** keys (19) on the microphone to **select** **90** to **150**.
- Short press the **PUSH** key (4) to **validate**. **a)** Return to the point **1** to set another menu or **b)** Short press the **PIT** key (18) to **validate** and **exit** the **MENU**. **F** disappears from the display.
- If no key is pressed, the unit **exits MENU** after 10 seconds. **F** disappears from the display.

Default value is **150**

## 27) POWER LIMITATION

If a power amplifier is used, this function limits the output power of your radio.

Long Press **PUSH** key (4) to **enter** the **MENU**. **F** is displayed.

- Turn the **CH** rotary knob (4) or use the **UP/DN** keys (19) on the microphone to **select** the **POWER LIMITATION** the menu.
- Press the **PUSH** key (4). The current setting flashes in the display.
- Turn the **CH** rotary knob (4) or use the **UP/DN** keys (19) on the microphone to **select** **0F**, **R4**, **R0**
- Press the **PUSH** button (4) again to **validate**. The value stops flashing. **a)** Go back to point **1** to set another function or **b)** Press the **PIT** key (18) to **validate** and **exit** the **MENUS**. **F** disappears from the display.
- If no key is pressed, the device **exits** the **MENUS** after 10 seconds. **F** disappears from the display.

**0F** no power limitation

**R4** power limited to 4 W

**R0** power limited to 10 W

## 28) ECHO LEVEL

Long Press **PUSH** key (4) to **enter** the **MENU**. **F** is displayed.

- Turn the **CH** rotary knob (4) or use the **UP/DN** keys (19) on the microphone to **select** the **ECHO LEVEL** the menu.
- Press the **PUSH** key (4). The current setting flashes in the display.
- Turn the **CH** rotary knob (4) or use the **UP/DN** keys (19) on the microphone to **set** the value. There are **54** «LEVEL» ; default: **25**.
- Short press the **PUSH** key (4) to **validate**. **a)** Return to the point **1** to set another menu or **b)** Short press the **PIT** key (18) to **validate** and **exit** the **MENU**. **F** disappears from the display.
- If no key is pressed, the unit **exits MENU** after 10 seconds. **F** disappears from the display.

## 29) ECHO DELAY

Long Press **PUSH** key (4) to **enter** the **MENU**. **F** is displayed.

- Turn the **CH** rotary knob (4) or use the **UP/DN** keys (19) on the microphone to **select** the **ECHO DELAY** the menu.
- Press the **PUSH** key (4). The current setting flashes in the display.
- Turn the **CH** rotary knob (4) or use the **UP/DN** keys (19) on the microphone to **set** the value. There are **54** «DELAY» ; default: **30**.
- Short press the **PUSH** key (4) to **validate**. **a)** Return to the point **1** to set another menu or **b)** Short press the **PIT** key (18) to **validate** and **exit** the **MENU**. **F** disappears from the display.
- If no key is pressed, the unit **exits MENU** after 10 seconds. **F** disappears from the display.

## 30) TEMPERATURE UNIT

Selects the unit of temperature measurement.

See § **DCITEMP** page 13

Long Press **PUSH** key (4) to **enter** the **MENU**. **F** is displayed.

- Turn the **CH** rotary knob (4) or use the **UP/DN** keys (19) on the microphone to **select** the **TEMP SET** the menu.
- Press the **PUSH** key (4). The current setting flashes in the display.
- Turn the **CH** rotary knob (4) or use the **UP/DN** keys (19) on the microphone to **select** **C** ou **F**.
- Press the **PUSH** button (4) again to **validate**. The value stops flashing. **a)** Go back to point **1** to set another function or **b)** Press the **PIT** key (18) to **validate** and **exit** the **MENUS**. **F** disappears from the display.
- If no key is pressed, the device **exits** the **MENUS** after 10 seconds. **F** disappears from the display.

**C** to give the temperature in Celsius.

F to give the temperature in Fahrenheit.

Default **C**.

### 31) TEMPERATURE PROTECTION

Your PRESIDENT WASHINGTON is fitted with two connectors for connecting fans. You can use this menu to set the temperature at which the fans are switched on. They will switch off automatically as soon as the temperature falls below 5°C.

Long Press **PUSH** key (4) to *enter* the MENU. **F** is displayed.

1. Turn the **CH** rotary knob (4) or use the **UP/DN** keys (19) on the microphone to select the **TEMP PROTECTION** the menu.
2. Press the **PUSH** key (4). The current setting flashes in the display.
3. Turn the **CH** rotary knob (4) or use the **UP/DN** keys (19) on the microphone to select the value, between 50°C and 80°C; Default: **50**.
4. Press the **PUSH** button (4) again to validate. The value stops flashing. **a)** Go back to point 1 to set another function or **b)** Press the **PTT** key (18) to validate and exit the **MENUS**. **F** disappears from the display.
5. If no key is pressed, the device exits the **MENUS** after 10 seconds. **F** disappears from the display.

### 32) RESET

This function can be used to erase memories, the SCAN SKIP memory, restore tape names or all factory settings.

Long press the **PUSH** key (4) to access the MENUS.

1. Turn the **CH** rotary knob (4) or use the **UP/DN** keys (19) on the microphone to select the **RESET** menu.
2. Press the **PUSH** key (4). The current setting flashes in the display.
3. Turn the **CH** rotary knob (4) or use the microphone **UP/DN** keys (19) to select **F1, F2, F3, F4, bd, SC** or **RL**.
4. Pressing the **PUSH** key (5) again resets the selected option. The device displays -- and restarts.
5. If no key is pressed, the device exits the **MENUS** after 10 seconds. **F** disappears from the display.

**F1, F2, F3, F4** empties the corresponding memory

**bd** restores the name of all tape

**SC** empties the memory of the SCAN SKIP. All channels are now accessible via the SCAN function.

**RL** restores all factory settings.

## E) TECHNICAL CHARACTERISTICS

### 1) GENERAL

- Modulation modes	: AM / FM / USB / LSB
- Frequency ranges	: from 28.000 MHz to 29.700 MHz : from 24.890 MHz to 24.990 MHz
- Antenna impedance	: 50 ohms
- Power supply	: 13.8 V
- Dimensions	: 185 (L) x 172 (P) x 56 (H) mm
- Weight	: 1.190 kg
- Accessories supplied	: 1 microphone electret UP/DOWN with support, mounting cradle, screws and fused power cord.

### 2) TRANSMISSION

- Frequency allowance	: +/- 200 Hz
- Carrier power	: 80 W PEP AM / 50 W FM : 80 W PEP USB LSB
- Transmission interference	: inferior to 4 nW (- 54 dBm)
- Audio response	: 300 Hz to 3 KHz in AM/FM/USB/LSB
- Emitted power in the adj. channel	: inferior to 20 µW
- Microphone sensitivity	: 3,0 mV
- Drain	: < 12 A max. with modulation (13.8 V)
- Modulated signal distortion	: 2 %

### 3) RECEPTION

- Maxi. sensitivity at 20 dB sinad	: 0,5 µV - 113 dBm (AM) : 0,35 µV - 116 dBm (FM) : 0,28 µV - 118 dBm (USB/LSB)
- Frequency response	: 300 Hz to 3 kHz in AM/FM
- Adjacent channel selectivity	: 60 dB
- Maximum audio power	: 3 W
- Squelch sensitivity	: minimum 0,2 µV - 120 dBm : maximum 1 mV - 47 dBm
- Frequency image rejection rate	: 60 dB
- Intermediate frequency rej. rate	: 70 dB
- Drain	: 200 ~ 600 mA maximum (13.8 V)

### 4) FANS (Optional - Not supplied with radio)

- Power supply	: 12 V
- Power	: max. 1.5 W
- Dimensions	: 40 x 40 mm
- Connector	: 2 plots

## F) TROUBLE SHOOTING

### 1) YOUR transceiver RADIO WILL NOT TRANSMIT OR YOUR TRANSMISSION IS OF POOR QUALITY

- Check that the antenna is correctly connected and that the SWR is properly adjusted.
- Check that the microphone is properly plugged in.
- Check that the **RF POWER** switch (2) is set on maximum.
- Check that the **MIC GAIN** switch (8) is set on maximum.
- Check that the **CLARIFIER** (7) switch is set on central position.

### 2) YOUR transceiver RADIO WILL NOT RECEIVE OR RECEPTION IS POOR

- Check that the squelch level is properly adjusted.
- Check that the volume is set to a comfortable listening level.
- Check that the antenna is correctly connected and that the SWR is properly adjusted.
- Check that you are using the same modulation mode as your correspondent.
- Check that the **RFGAIN** (9) is set on maximum.
- Check that the **CLARIFIER** (7) switch is set on central position.

### 3) YOUR transceiver WILL NOT LIGHT UP

- Check the power supply.
- Check the connection wiring.
- Check the fuse.

## G) GLOSSARY

### INTERNATIONAL PHONETIC ALPHABET

<b>A</b> Alpha	<b>H</b> Hotel	<b>O</b> Oscar	<b>V</b> Victor
<b>B</b> Bravo	<b>I</b> India	<b>P</b> Papa	<b>W</b> Whiskey
<b>C</b> Charlie	<b>J</b> Juliett	<b>Q</b> Quebec	<b>X</b> X-ray
<b>D</b> Delta	<b>K</b> Kilo	<b>R</b> Romeo	<b>Y</b> Yankee
<b>E</b> Echo	<b>L</b> Lima	<b>S</b> Sierra	<b>Z</b> Zulu
<b>F</b> Foxtrott	<b>M</b> Mike	<b>T</b> Tango	
<b>G</b> Golf	<b>N</b> November	<b>U</b> Uniform	

**SIMPLIFIED EU  
DECLARATION OF CONFORMITY**

*Hereby, Groupe President Electronics, declares that the radio equipment :*

*Brand: **PRESIDENT***

*Type: **TXPR901***

*Commercial Name: **WASHINGTON***



*is in compliance with Directive 2014/53/EU.*

*The full text of the EU declaration of conformity is available at the following internet address:*

*<https://president-electronics.com/DC/TXPR901>*



## GENERAL WARRANTY CONDITIONS

This device is guaranteed **2 years** parts and labour in its country of purchase against any manufacturing defects validated by our technical department. \*The After-sales Service of PRESIDENT reserves the right not to apply the warranty if a breakdown is caused by an antenna other than those distributed by PRESIDENT, and if said antenna is at the origin of the breakdown. An extension of **3 years** warranty is proposed systematically for the purchase and use of a PRESIDENT antenna, bringing the total duration of the warranty to **5 years**. In order to be valid, the warranty certificate must be returned within a period of 30 days after the purchase date to the After-sales Service of the company Groupe President Electronics, or any foreign subsidiary.

It is recommended to carefully read the following conditions and to respect them under penalty of losing their benefit.

- \* To be valid the warranty certificate must be returned to us at the latest 1 month after the purchase.
- \* Please duly complete the warranty certificate on the right hand side of the page, detach it (portion to be removed marked by dotted line) and send it back.
- \* Any repair under warranty will be free and the return delivery costs will be borne by our company.
- \* A purchase proof must be necessarily included with the device to be repaired.
- \* The dates listed on the warranty certificate and proof of purchase must match.
- \* Do not proceed with the installation of the device without reading the user manual.
- \* No spare part will be sent nor exchanged by our services under warranty.

The warranty is only valid in the country of purchase.

### Exclusions (are not covered):

- \* Damages caused by accident, shock or inadequate packaging.
- \* Power transistors, microphones, lights, fuses and the non respect of the installation and use of specifications (including but not limited to antenna used with too high power, final output power transistors (SWR), inversion of polarities, bad connections, overvoltage,...)
- \* The warranty cannot be extended due to the non-availability of the device while it is being serviced at our technical services location, nor by a change of one or more components or spare parts.
- \* Transceivers which have been modified. The warranty application is excluded in case of modification or poor maintenance done by a third party not approved by our company.

### If you note malfunctions:

- \* Check the power supply of your device and the quality of the fuse.

- \* Check that the antenna, the microphone.... are correctly connected.
- \* Check that the squelch level is properly adjusted; the programmed configuration is the correct one...
- \* In case the device is not under warranty, the repair and return of the device will be charged.
- \* All related documents must be preserved even after the end of the warranty period and if you resell your device, given to the new owner for the After-sales follow-up.
- \* In case of real malfunction, please contact your dealer first; they will decide action to be taken.
- \* In case of an intervention not covered by the warranty, an estimate will be established before any repair.

Thank you for your trust in the PRESIDENT quality and experience. We recommend that you read this manual carefully so that you are completely satisfied with your purchase. Do not forget to return the detachable warranty certificate on the right hand side of this page; it is very important for the identification of your device during a possible rendering of our services.

Technical Manager  
and  
Quality Manager



.....  
Date of purchase : .....

Type : Radio Amateur WASHINGTON

Serial N°: .....



NOT COVERED BY THE WARRANTY  
WITHOUT THE DEALER STAMP





## GENERAL WARRANTY CONDITIONS

This device is guaranteed **2 years** parts and labour in its country of purchase against any manufacturing defects validated by our technical department. PRESIDENT After Sales Service department reserves the right not to apply the warranty in the event a breakdown is caused by an antenna other than those distributed by PRESIDENT. An extension of **3 years** warranty is proposed systematically for the simultaneous purchase of a device and a PRESIDENT antenna, bringing the total duration of the warranty to **5 years**. In order to be valid, the warranty registration must be completed and submitted within a period of 30 days after the purchase date to PRESIDENT ELECTRONICS online at [www.president-electronics.us/warranty-registration](http://www.president-electronics.us/warranty-registration). You can also access this warranty registration page by using your smartphone to read (application must be available) the QR code. You will receive a confirmation email if the registration is successfully completed. Please keep a copy of this email for your records.

Any repair under warranty will be without charge and the return delivery costs will be borne by PRESIDENT. A proof of purchase sales receipt must be included with the device to be repaired. The dates listed on the warranty registration and proof of purchase must match. In case the device is not under warranty, the repair and return of the device will be charged.

No spare parts will be sent nor exchanged by PRESIDENT under warranty. Do not proceed with the installation of the device without reading the user manual.

The warranty is only valid in the country of purchase.

### Exclusions (not covered by Warranty):

- Damages caused by accident, shock or inadequate packaging.
- Power transistors, microphones, lights, fuses and the disrespect of the installation and use of specifications (including but not limited to antenna used with too high power, final output power transistors (SWR), inversion of polarities, bad connections, over voltage...).
- The warranty cannot be extended due to the non-availability of the device while it is being serviced at PRESIDENT After Sales Service department, nor by a change of one or more components or spare parts.
- Transceivers which have been modified. The warranty application is excluded in case of modification or poor maintenance done by a third party not approved by PRESIDENT ELECTRONICS.

### If you note a malfunction:

- Check the power supply of your device and the quality of the fuse.

- Check that the antenna, the microphone are correctly connected.
- Check that the squelch level is properly adjusted; the programmed configuration is the correct one.
- In the event of a real malfunction, please contact your dealer first. He will decide what action should be taken.

In case of an intervention not covered by warranty, an estimate will be established before any repair.

Thank you for your confidence in the PRESIDENT quality and experience. We recommend that you read this manual carefully so that you are completely satisfied with your purchase.

Technical Manager  
and  
Quality Manager

### Warranty Registration





## PRISE MICRO À 6 BROCHES • CONEXIÓN DEL MICRO 6 PINS

### 6-PIN MICROPHONE PLUG • WTYK MIKROFONU 6-PIN

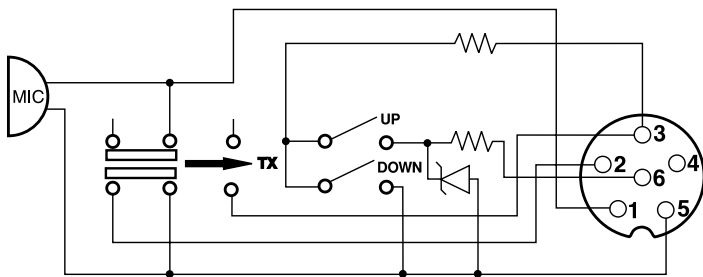

1	Modulation	Modulación	Modulation	Modulacja
2	RX	RX	RX	RX
3	TX - UP/DOWN	TX - UP/DOWN	TX - UP/DOWN	TX - UP/DOWN
4				
5	Masse	Masa	Ground	Masa
6	Alimentation	Alimentación	Power Supply	Zasilanie

## CTCSS TONES LIST • LISTE TONALITES CTCSS •

### LISTA DE TONALIDADES CTCSS • LISTA DOS TONS CTCSS

No.	Freq. (Hz)	No.	Freq. (Hz)	No.	Freq. (Hz)
00 - $\text{dB}$	OFF	13	103.5	26	162.2
01	67.0	14	107.2	27	167.9
02	71.9	15	110.9	28	173.8
03	74.4	16	114.8	29	179.9
04	77.0	17	118.8	30	186.2
05	79.7	18	123.0	31	192.8
06	82.5	19	127.3	32	203.5
07	85.4	20	131.8	33	210.7
08	88.5	21	136.5	34	218.1
09	91.5	22	141.3	35	225.7
10	94.8	23	146.2	36	233.6
11	97.4	24	151.4	37	241.8
12	100.0	25	156.7	38	250.3

## DCS CODE LIST • LISTE CODES DCS

### LISTA DE LOS CÓDIGOS DCS • LISTA DOS CÓDIGOS DCS

Code No.	DCS (Octal)	Code No.	DCS (Octal)	Code No.	DCS (Octal)	Code No.	DCS (Octal)
1	023	27	152	53	311	79	466
2	025	28	155	54	315	80	503
3	026	29	156	55	325	81	506
4	031	30	162	56	331	82	516
5	032	31	165	57	332	83	523
6	036	32	172	58	343	84	526
7	043	33	174	59	346	85	532
8	047	34	205	60	351	86	546
9	051	35	212	61	356	87	565
10	053	36	223	62	364	88	606
11	054	37	225	63	365	89	612
12	065	38	226	64	371	90	624
13	071	39	243	65	411	91	627
14	072	40	244	66	412	92	631
15	073	41	245	67	413	93	632
16	074	42	246	68	423	94	654
17	114	43	251	69	431	95	662
18	115	44	252	70	432	96	664
19	116	45	255	71	445	97	703
20	122	46	261	72	446	98	712
21	125	47	263	73	452	99	723
22	131	48	265	74	454	100	731
23	132	49	266	75	455	101	732
24	134	50	271	76	462	102	734
25	143	51	274	77	464	103	743
26	145	52	306	78	465	104	754

## NOTES

---

---

---

---

---

---

---

---

---

---

---

---

---

---

---

---

---

---

---

---

**NOTES**

---



---



---



---



---



---



---



---



---



---



---



---



---



---



---



---



---



---



---



---



---



Groupe  
**PRESIDENT**  
 ELECTRONICS

SIEGE SOCIAL/HEAD OFFICE - FRANCE  
 Route de Sète - BP 100 - 34540 BALARUC  
 Site Internet : <http://www.president-electronics.com>  
 E-mail : [groupe@president-electronics.com](mailto:groupe@president-electronics.com)



Group  
**PRESIDENT**  
 ELECTRONICS USA

HEAD OFFICE/SIÈGE SOCIAL: USA - 1007 Collier Center Way, Naples, Florida 34110  
 Web: <http://www.president-electronics.us> • Phone: +1 239.302.3100  
 Email: [info@president-electronics.us](mailto:info@president-electronics.us)



PRINTED IN PRC

2264/04-24-V0 22

**PRESIDENT**